

BRANDON



Pizza Oven

Installation guide and owner's manual

TECHO — BLOC

TABLE OF CONTENTS

COMPONENTS	3
OVERALL DIMENSIONS	4
POSITIONING REFERENCE PER LAYER	5
CONCRETE PAD PREPARATION	5
INSTALLATION OF BLOCKS.....	6
OPERATION INSTRUCTIONS	
WARNINGS.....	8
USING.....	8
MAINTENANCE AND CLEANING.....	9
WARRANTY	10

GENERAL INFORMATION

PLEASE SAVE THIS OWNER'S MANUAL FOR FUTURE REFERENCE

Carefully read the information in this manual before installing and using the pizza oven. Improper installation, operation and maintenance can result in serious injury, fire and/or damages not covered by the warranty.

IMPORTANT

Check with your municipality for regulations on the installation and use of an outdoor Pizza Oven. We also recommend that you contact your home insurance company and advise them of the acquisition of your new Techo-Bloc Pizza Oven.

This Pizza Oven is for OUTDOOR USE ONLY. Check with your municipality for minimum clearance distances. Make sure that there is nothing directly above the pizza oven area that can be a potential fire and/or injury hazard.

COMPONENTS



A. Brandon 180 mm corner block (x16)

180 x 250 x 360 mm
7 1/16 x 9 13/16 x 14 3/16 po



B. Brandon 90 mm corner block (x16)

90 x 250 x 360 mm
3 3/16 x 9 13/16 x 14 3/16 po



C*. Brandon 180 mm corner block 110 (2x)

180 x 250 x 110 mm
7 1/16 x 9 13/16 x 4 5/16 po



D*. Piedimonte cap 12 x 30 - 24 (12x)

57 x 298 x 610 mm
2 1/4 x 11 3/4 x 24 po



E*. Brandon 90 mm corner block 279 (x2)

90 x 250 x 279 mm
3 3/16 x 9 13/16 x 11 po



F*. Brandon 90 mm corner block 229 (x2)

90 x 250 x 229 mm
3 3/16 x 9 13/16 x 9 po



G*. Brandon 90 mm corner block 241 (x2)

90 x 250 x 241 mm
3 3/16 x 9 13/16 x 9 1/2 po



H*. Brandon 90 mm corner block 81 (x2)

90 x 250 x 81 mm
3 3/16 x 9 13/16 x 3 3/16 po



I*. Brandon 90 mm corner block 110 (x6)

90 x 250 x 110 mm
3 3/16 x 9 13/16 x 4 5/16 po

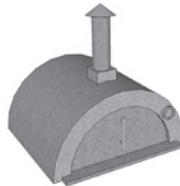

J. Forno appliance (x1)

* Cut as per dimension required.

OVERALL DIMENSIONS

Below are the overall dimensions of the pizza oven. The height shown is the total height (including buried portion). The pizza oven should be buried 4" below finished grade.

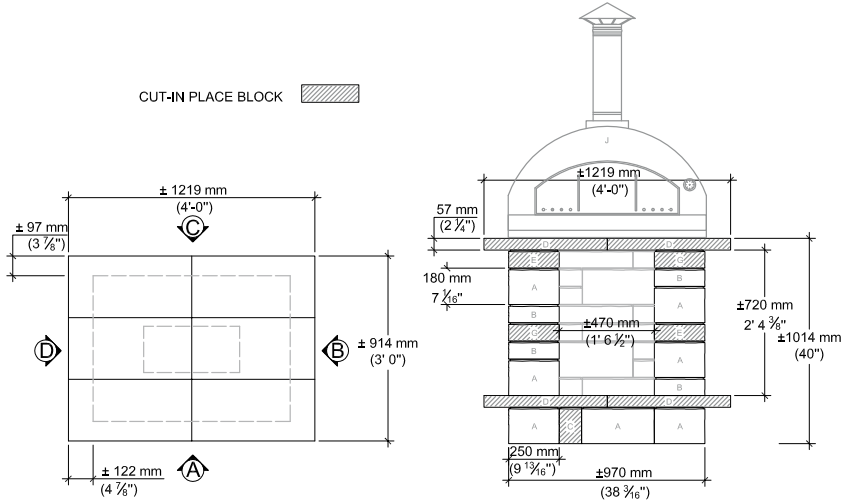

PLAN VIEW

ELEVATION A

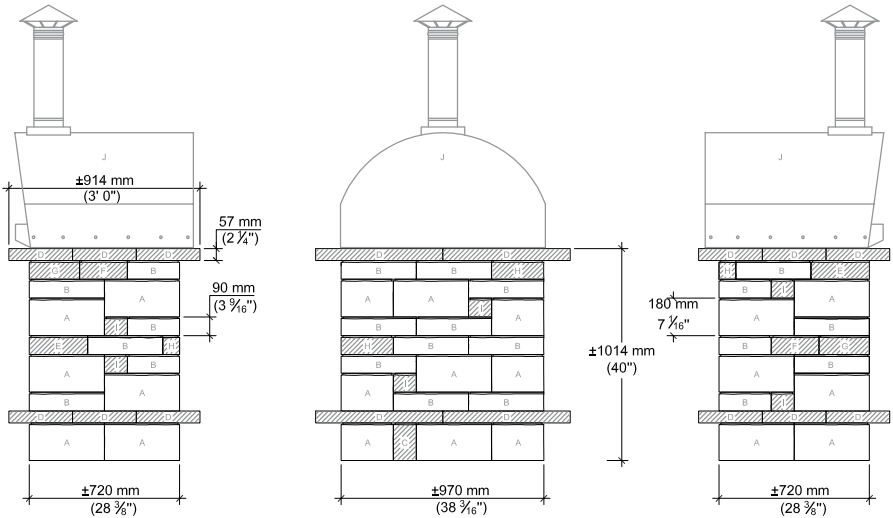

ELEVATION B

ELEVATION C

ELEVATION D

POSITIONING REFERENCE PER LAYER

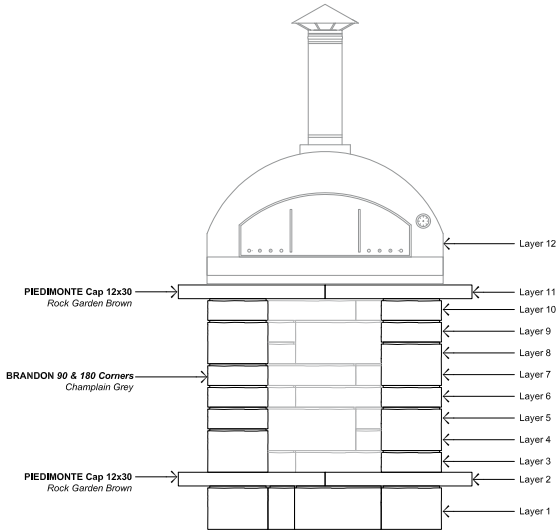

CONCRETE PAD PREPARATION

The following drawings are **NOT ENGINEERED DRAWINGS**. They are provided as a general guidance for the consideration of the installer. Concrete tubes extending to frost line may be required as per local code. Check your local building codes before installing.

Determine the desired location and excavate as necessary to accommodate a minimum of 6" of $\frac{3}{4}$ " clean stone, 4" of reinforced concrete pad (see drawings below for steel rod placement) and 4" of the pizza oven bottom section below finished grade.

CONCRETE PAD DRAWING FOR PIZZA OVEN

(a) #3 rebar ($\frac{3}{8}$ ") / (Metric size: 10M)

(b) 4" concrete slab (4000 psi)

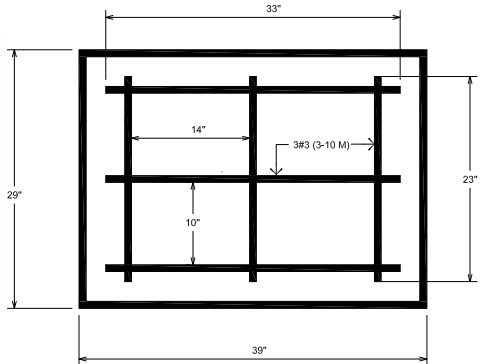
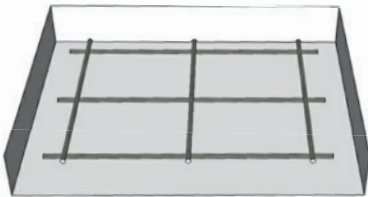

INSTALLATION OF BLOCKS

LAYER 1

Apply concrete adhesive and fix the blocks onto the concrete pad as shown on the drawing. Make sure that this layer and each subsequent layer is level.

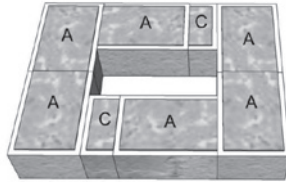

LAYER 1

LAYER 2 TO 11

Apply concrete adhesive at each layer and install as shown on the drawing.

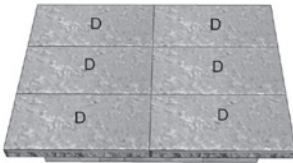

LAYER 2

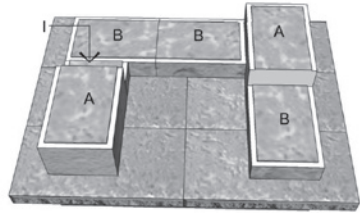

LAYER 3

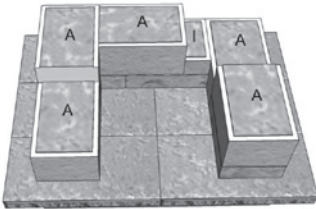

LAYER 4

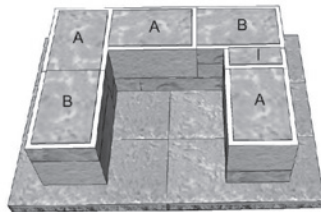

LAYER 5

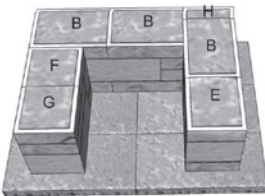

LAYER 6

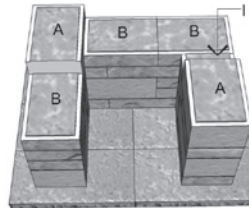

LAYER 7

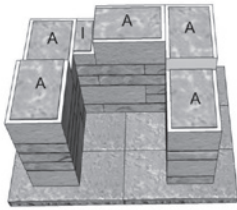

LAYER 8

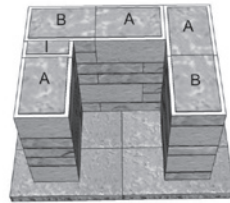

LAYER 9

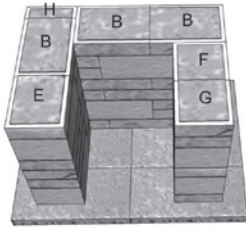

LAYER 10

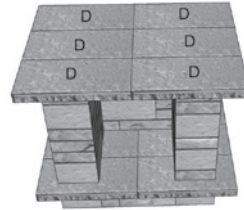

LAYER 11

LAYER 12

Place the Forno appliance by hanging it directly on the blocks.

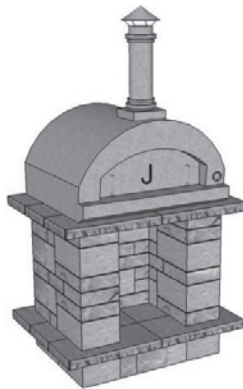

LAYER 12

OPERATION INSTRUCTIONS

WARNINGS

- The wood fired oven is designed for outdoor use only.
- Always place the oven on a flat surface and out of strong winds.
- Always keep children and pets away from the oven when in use. The temperatures could be extremely high and cause serious burns.
- Always use heat resistant tools while cooking. Plastic kitchen tools and others similar items will not withstand the high temperatures in your oven and should be avoided.
- Although the oven is well insulated, improper use can cause the external surfaces to overheat. For this reason, all contact with the oven's external surfaces should be avoided during operation. If not properly used, the oven may cause fires. To reduce the risk of fire follow the instructions and use only well dried seasoned wood as fuel.
- Only use suitable cookware for high temperature, such as terracotta or cast iron pots.
- Flames can come out of the mouth of the oven. Keep away any flammable liquid or material. Please read the oven manual before assembling it. Incorrect assembly or installation may cause damages and bodily harm. For additional information please contact your local dealer or a professional oven installer.
- DO NOT EXTINGUISH FIRE USING WATER.
- DO NOT throw logs, place them carefully instead. Throwing logs into the oven will damage the inner components of the oven. Do NOT use any flammable liquids in the nearby of the oven.
- DO NOT use any artificial or chemical fire lighters or alcohol to start the fire.
- DO NOT use any artificial wood or other chemical fuels.
- DO NOT burn any plastics, food packaging, wrap, etc.
- THE OVEN IS NOT AN INCINERATOR.

USING

First of all, remove the protection from the stainless steel parts.

TYPES OF WOOD

While any dried hardwood is the best for your oven, different dishes can be cooked by using different types of hardwood. Wood from fruit trees (apple, cherry, peach, etc.) can add delicious flavors and aromas to your food. Dry and well-seasoned hardwood will burn longer and at higher temperatures resulting more cost effective. Treated and resinous wood must be absolutely avoided. Being in contact with food, it can be dangerous for your health and affect the taste of food.

IGNITION

Fire must be lighted with small pieces of wood arranged radially above a paper pellet placed in the center of the cooking surface.

Feed the fire for about 20 minutes adding medium cut wood, wait until the temperature of the thermometer reaches about 400°C, then move all the embers on the left side with the poker supplied and hold them with the special accessory included, taking care not to extinguish the fire, also using the smoke exit valve situated on the chimney flue.

Keep feeding the fire with good quality wood even during the cooking of pizzas and other dishes.

EXTINGUISH THE FIRE

To extinguish the fire, close the oven with the door supplied holding the valve open and wait until the embers become ash. Once the fire has been completely extinguished, remove ashes. **NEVER USE WATER TO EXTINGUISH THE FIRE.**

OPERATING YOUR OVEN

Always remove the ashes when the oven is cool. Do not leave ashes and unburned pieces of embers for long periods as this will tend to collect moisture and may damage your oven. Sweep and clean the chimney flue once a year so that soot and ashes will not fall back into the oven. You can operate the oven all year long. However, when using it in the colder season, build your fire more slowly in order to avoid thermal shocks to the oven. This may damage your oven and increase the risk of cracking. If it happens to spill any juices or sauces during cooking, simply place the embers over the spot the next time you cook. This is one of the easiest self-cleaning tools available and the hot temperatures will burn off any residual drippings or food.

MAINTENANCE AND CLEANING

For the correct maintenance of the oven be sure, before lighting it, that there is nothing obstructing the chimney flue and the ashes from the previous use have been removed. When the fire is extinguished and the oven is cool, remove the ash using a brush and an ash bucket. Clean the oven floor with a brush and a wet cloth. The external surfaces can be cleaned with warm water and neutral soap.

When you have finished cooking, we recommend you to scatter the remaining embers on the entire cooking surface, half-close the door and wait until the oven is cool; this operation is recommended to keep the cooking surface always clean and free from dirt due to previous cooking. When the embers are cold, suck up or brush the residual ash. In this way, your oven will always be clean and ready for the next use.

WARRANTY

For FORNO appliance, please visit: <https://www.techo-bloc.com/products/forno/>

For warranty details and exclusions on TECNO-BLOC PRODUCTS, please visit our website at: <https://www.techo-bloc.com/contact-us/about-us/>

CANADA

MONTREAL

5255 Albert-Millichamp Street, Saint-Hubert, QC J3Y 8Z8

CHAMBLY

7800 Samuel-Hatt Street Chambly, QC J3L 6W4

OTTAWA

3455 Hawthorne Road, Ottawa, ON K1G 4G2

TORONTO

10 Freshway Drive, Vaughan, ON L4K 1S3

TORONTO

1050 Industrial Road, Ayr, ON N0B 1E0

USA

ILLINOIS

8201, 31st Street West, Rock Island, IL 61201

ILLINOIS

24312 W. Riverside Dr, Channahon, IL 60410

INDIANA

2397 County Road 27, Waterloo, IN 46793

MARYLAND

6710 Binder Lane, Elkridge, MD 21075

MASSACHUSETTS

70 East Brookfield Rd., North Brookfield, MA 01535

MINNESOTA

4372 170th Street West, Farmington, MN 55024

NEW YORK

55-65 South 4th Street, Bay Shore, NY 11706

NORTH CAROLINA

5135 Surrett Drive, Archdale, NC 27263

OHIO

97 Industrial Street, Rittman, OH 44270

PENNSYLVANIA

852 W. Pennsylvania Avenue, Pen Argyl, PA 18072

PENNSYLVANIA

23 Quarry Road, Douglassville, PA 19518

CONTACT US

TOLL FREE:

1.877.832.4625

WWW.TECHO-BLOC.COM

PROUD MEMBER OF

